

AMR

Odboje
przemysłowe
i magazynowe



O nas

- ▲ Firma AMR specjalizuje się w kompleksowym wykonaniu odbojnic przemysłowych w zakresie produkcji, doradztwa i montażu.

W naszej ofercie znajdziecie Państwo: odbojnice słupowe, proste, narożne typu L lub ochronne typu U oraz paletowe, bariery komunikacyjne, odbojnice liniowe drewniane, naprowadzacze.

Wszystkie produkty są dostosowywane pod indywidualne potrzeby klienta.

Zapraszamy do kontaktu.

Oferta

- ▲ odbojnice liniowe drewniane,
- ▲ odbojnice słupowe, proste, narożne typu L lub ochronne typu U oraz paletowe,
- ▲ bariery komunikacyjne,
- ▲ naprowadzacze kół,
- ▲ bariery drogowe (energochłonne).

AMR

📍 Okrzei 2/4,
66-400 Gorzów Wlkp.
NIP: 5991086926

🌐 amrodboje.pl
@ kontakt@amrodboje.pl

▲ Odbojnice drewniano - metalowe liniowe



- ▲ Preferowana grubość belki drewnianej 8 i 10 cm, wysokość 20cm i wielokrotność.

Uchwyty metalowe odbojnic drewnianych

Z widocznym mocowaniem



Uchwyt startowo-końcowy



Uchwyt łączący



Uchwyt narożny



Z niewidocznym mocowaniem



Uchwyt startowo-końcowy



Uchwyt łączący



Uchwyt narożny



▲ Odbojnica słupowa

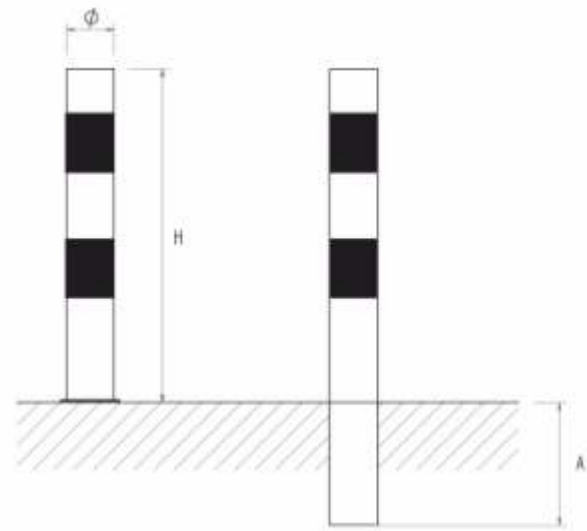

- ▲ Preferowane średnice rur 60,3, 76,1, 108, 114,3, 133 i 159 mm.

▲ Odbojnica prosta

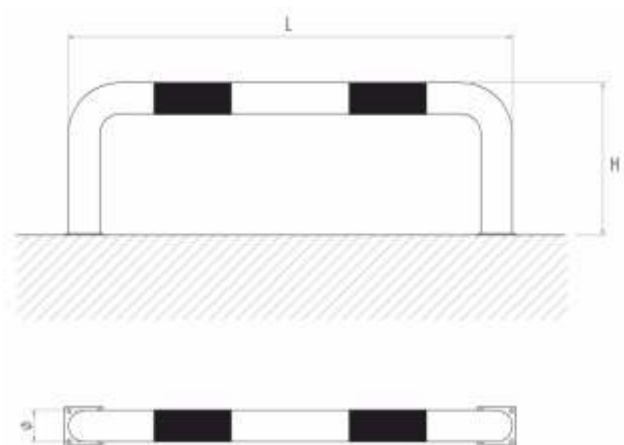

- ▲ Preferowane średnice rur 60,3, 76,1, 108, 114,3 i 133 mm.

▲ Odbojnica narożna

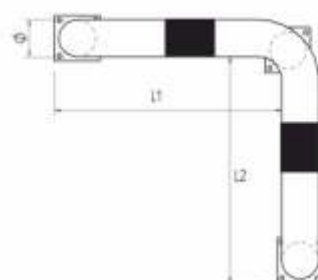
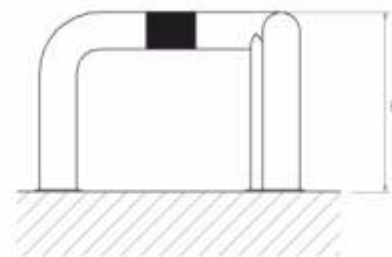

▲ Preferowane średnice rur 60,3, 76,1, 108, 114,3 i 133 mm.

▲ Odbojnica typ U2



▲ Preferowane średnice rur 60,3, 76,1, 108, 114,3 i 133 mm.

▲ Odbojnica typ U3

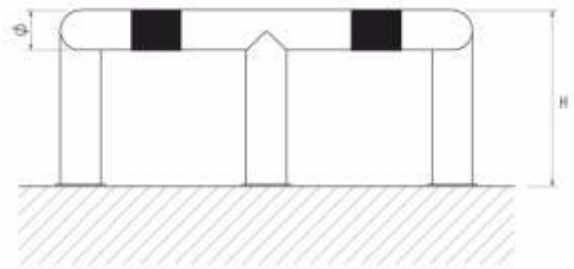

▲ Preferowane średnice rur 60,3, 76,1, 108, 114,3 i 133 mm.

▲ Odbojnica typ U4

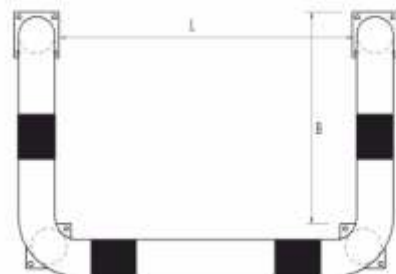
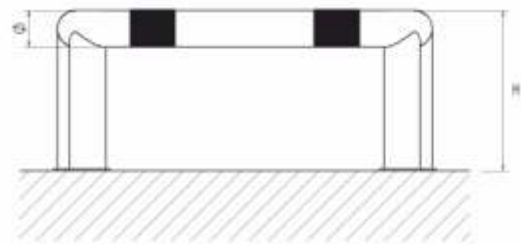

▲ Preferowane średnice rur 60,3, 76,1, 108, 114,3 i 133 mm.

▲ Odbojnica paletowa prosta

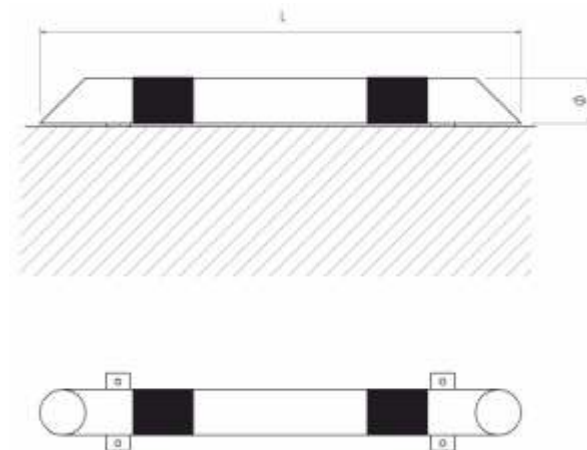

▲ Preferowane średnice rur 60,3, 76,1, 108, 114,3 i 133 mm.

▲ Odbojnica paletowa narożna

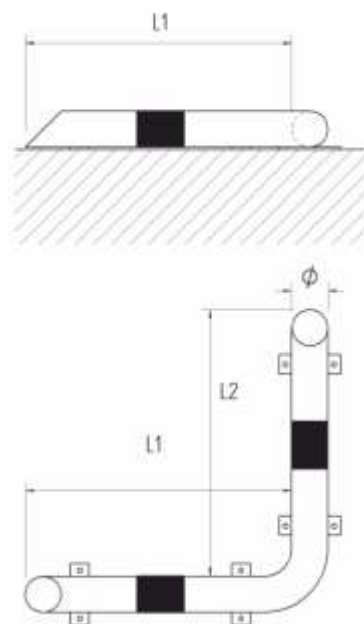

▲ Preferowane średnice rur 60,3, 76,1, 108, 114,3 i 133 mm.

▲ Odbojnica latarni i hydrantów

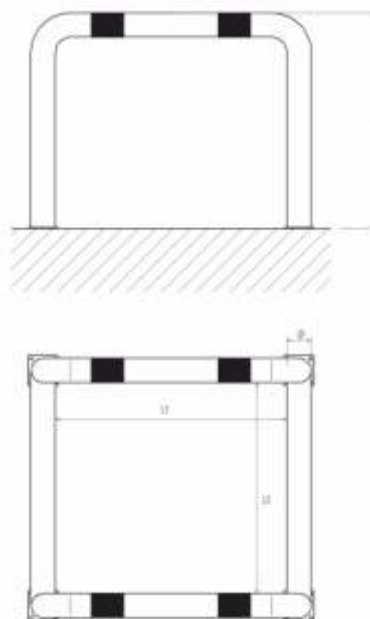

▲ Preferowane średnice rur 60,3, 76,1, 108 mm.

▲ Barierka komunikacyjna

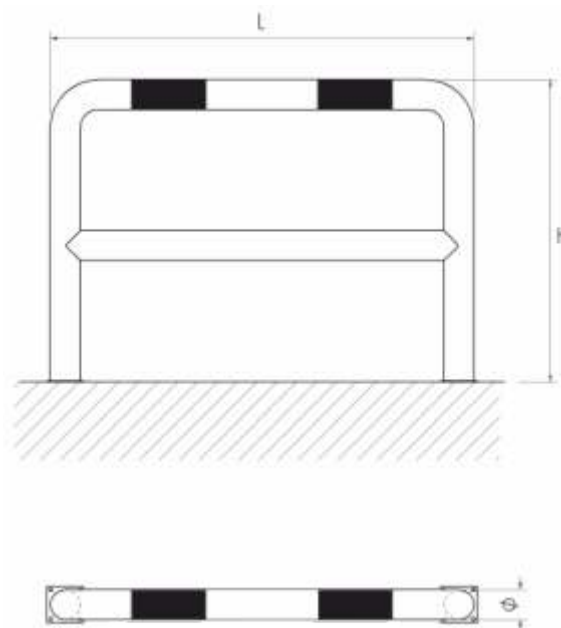

▲ Preferowane średnice rur 48,3, 60,3, 76,1, 108, 114,3 i 133 mm.

▲ Barierka komunikacyjna z progiem

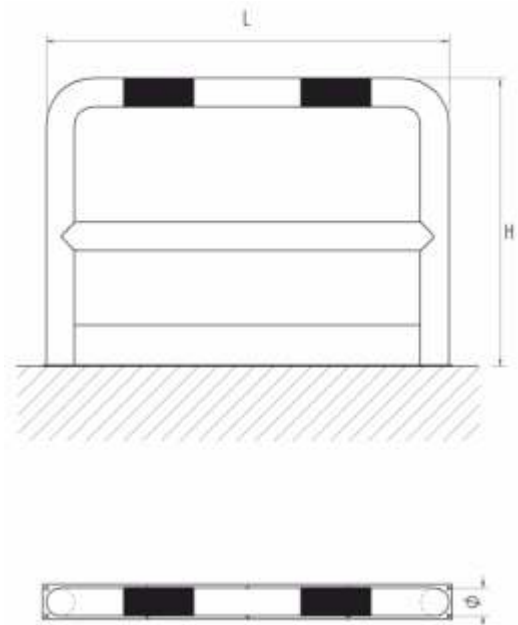

- ▲ Preferowane średnice rur 48,3, 60,3, 76,1, 108, 114,3 i 133 mm.

▲ Naprowadzacz kół

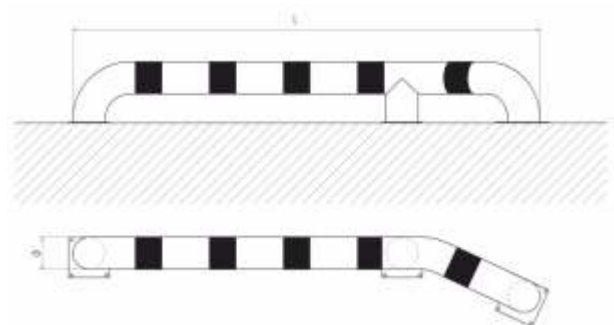

- ▲ Preferowane średnice rur 133, 159, i 168 mm.

Realizacje



Realizacje



Realizacje



Realizacje

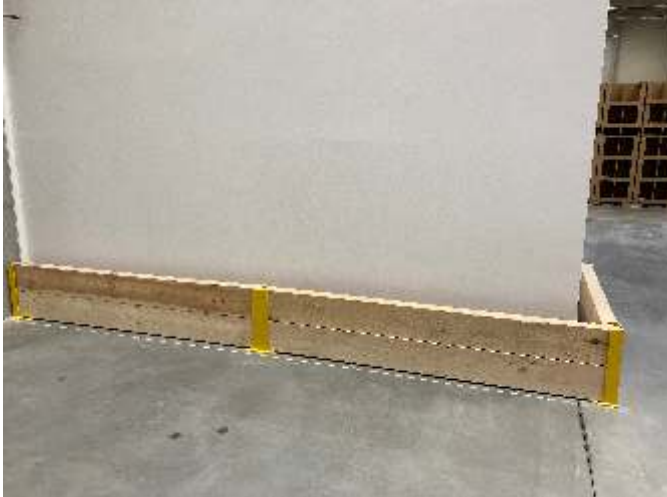

Realizacje





NIE KRZYWDŹ

